

Médiatrice de $[AB]$

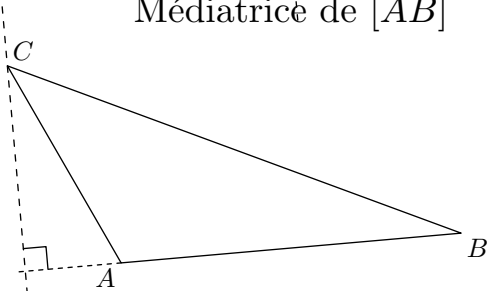

Hauteur issue de C

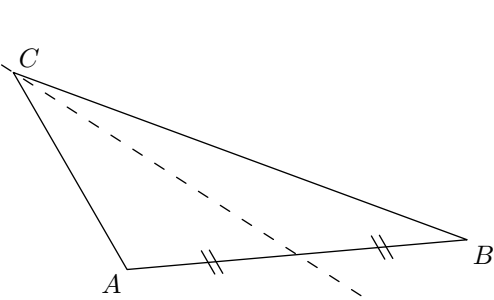

Médiane issue de C

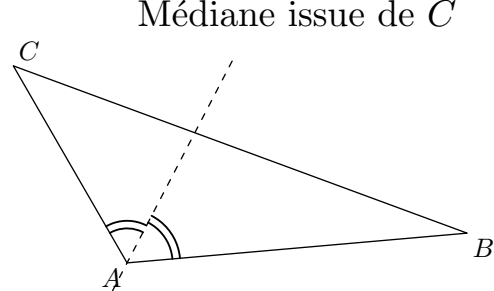

Bissectrice de l'angle \widehat{CAB}

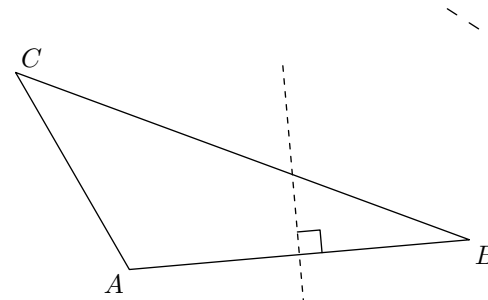

Médiatrice de $[AB]$

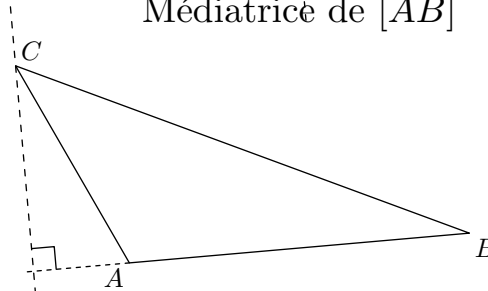

Hauteur issue de C

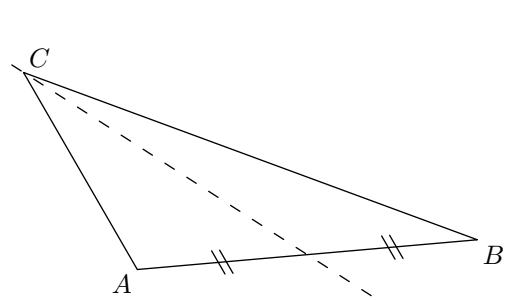

Médiane issue de C

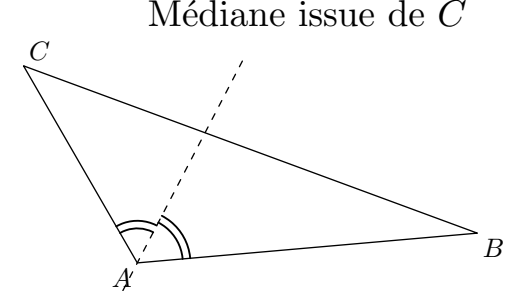

Bissectrice de l'angle \widehat{CAB}

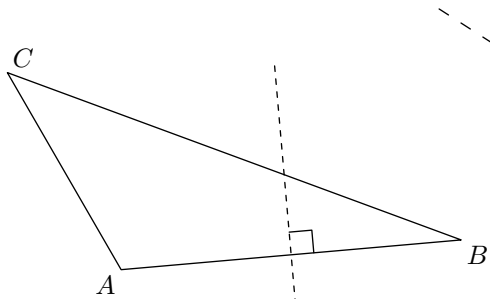

Médiatrice de $[AB]$

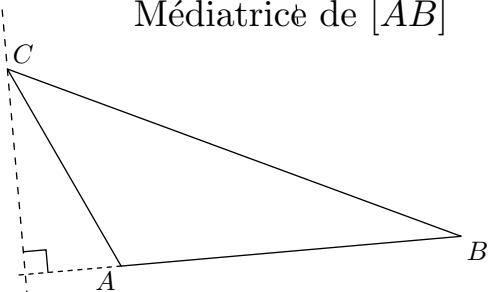

Hauteur issue de C

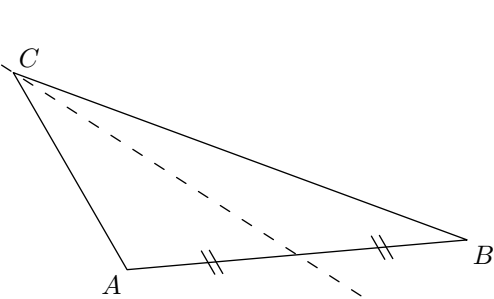

Médiane issue de C

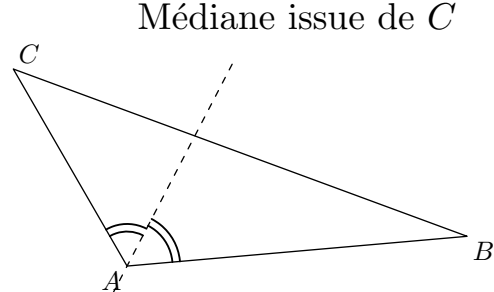

Bissectrice de l'angle \widehat{CAB}

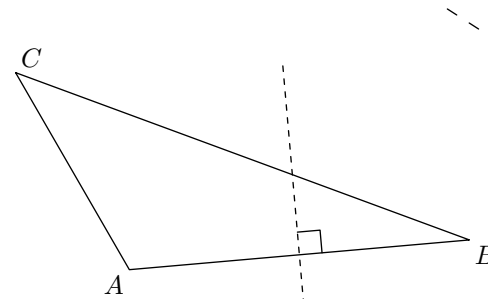

Médiatrice de $[AB]$

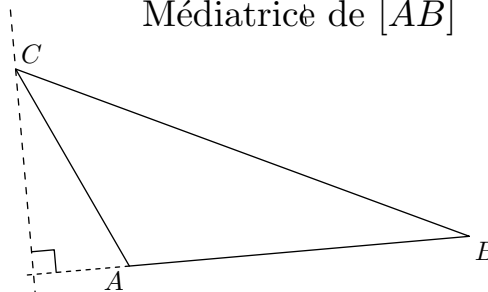

Hauteur issue de C

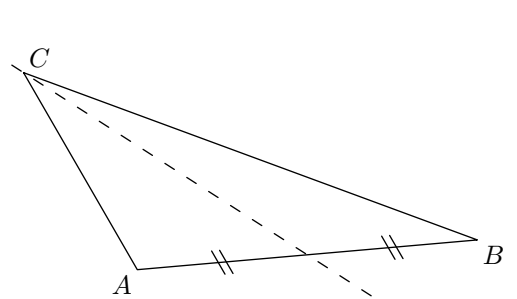

Médiane issue de C

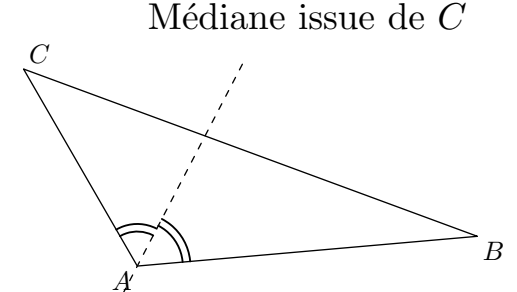

Bissectrice de l'angle \widehat{CAB}